

Model: TST024T

Locked type, terminal output, suspension installation ; The faulty wiring can lead to product damage; The output is linear with primary test current, and the output signal can be directly enter automatic control equipment or PLC port.

Safety indexes:

Flame retardant: UL94-V0

Working temperature: $-10^{\circ}\text{C} \sim +70^{\circ}\text{C}$

Storage temperature: $-40^{\circ}\text{C} \sim +85^{\circ}\text{C}$

Dielectric strength: 2.5KV 50Hz 1min

Overload capacity: 8 times 0.1S

Waterproof level: IP00



Technical parameter:

Rated input	100~300	A
Input measure range	$I_p * 120\%$	A
Rated output	4-20	mA
Accuracy	1	%
Linearity	0.5	%
Supply voltage($\pm 5\%$)	+12、+24	V
Current consumption	<35	mA
Load capacity max	6	V
Zero offset $T_A=25^{\circ}\text{C}$	≤ 0.1	mA
Response time	<350	ms
Working frequency	50-400	Hz
Weight	176	g

Connection diagram:

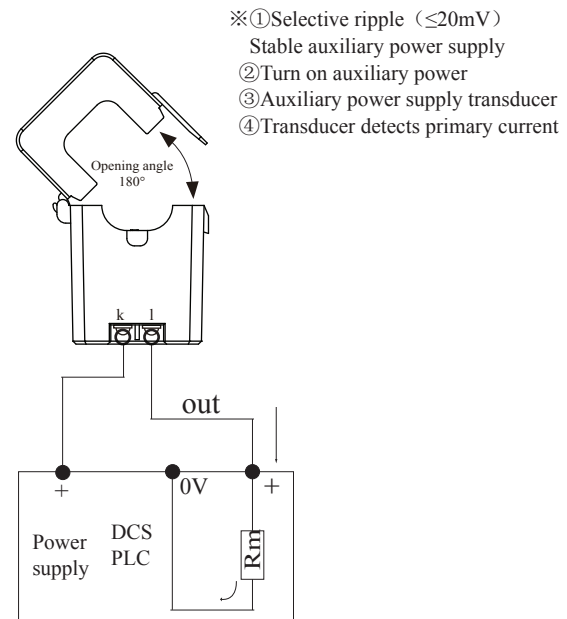

Dimensions:

